

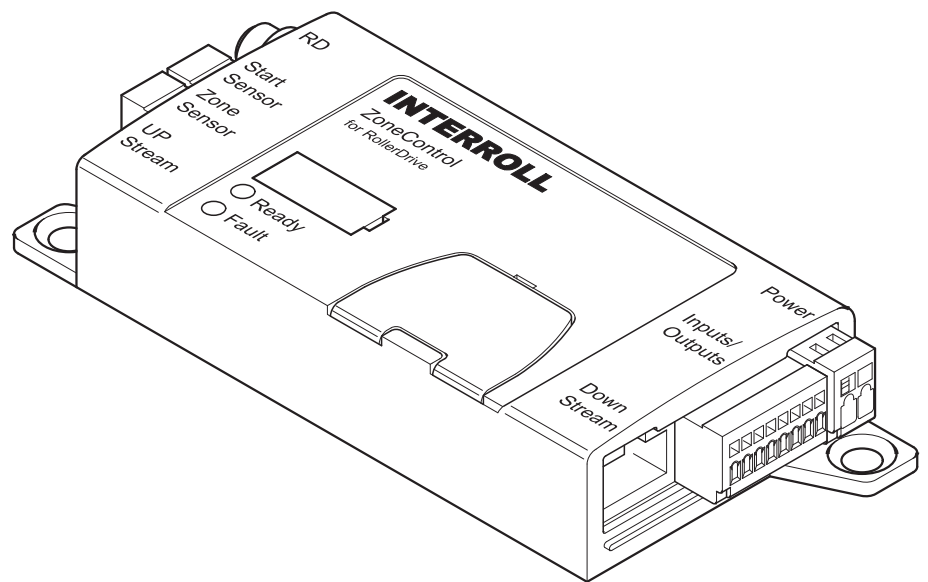

WE MAKE THE WORLD MOVE



## User manual

# Interroll ZoneControl

**Manufacturer's address**

Interroll Engineering GmbH  
Hoeferhof 16  
D-42929 Wermelskirchen  
Tel. +49 2193 23 0  
Fax. +49 2190 2022  
[www.interroll.com](http://www.interroll.com)

**Copyright**

The copyright of this manual remains with Interroll Engineering GmbH. The operating instructions contain technical regulations and drawings which may not be reproduced partially or in full, transmitted by any means, utilized without permission for competitive purposes or disclosed to third parties.

# Table of contents

<b>Introduction</b>	
Information about the operating instructions . . . . .	3
Warnings in this manual . . . . .	3
Further symbols . . . . .	4
<b>Safety</b>	
General safety instructions . . . . .	5
Intended use . . . . .	5
Unintended use . . . . .	5
Qualified persons . . . . .	6
Dangers . . . . .	7
Interfaces to other devices . . . . .	7
Operating modes . . . . .	7
<b>Product information</b>	
Product description . . . . .	8
Components . . . . .	11
Scope of delivery . . . . .	11
Label . . . . .	11
Technical data . . . . .	12
Meaning of the LEDs . . . . .	12
DIP switches . . . . .	13
Meaning of signals . . . . .	14
Dimensions . . . . .	14
<b>Transport and storage</b>	
Ambient conditions for transport and storage . . . . .	15
Transport . . . . .	15
Storage . . . . .	15
<b>Assembly</b>	
Warning notices concerning assembly . . . . .	16
Warning information relating to the electrical installation . . . . .	16
Installing the ZoneControl in a conveyor system . . . . .	17
Electrical installation . . . . .	17
Sensors . . . . .	19
Inputs and outputs . . . . .	20
Wiring diagrams . . . . .	22
<b>Initial startup and operation</b>	
Commissioning . . . . .	26
Operation . . . . .	26
Speed setting . . . . .	27
External influence on zero pressure accumulation conveying . . . . .	27
Complete clearing of a conveyor . . . . .	29
<b>Maintenance and cleaning</b>	
Warnings concerning maintenance and cleaning . . . . .	30
Maintenance . . . . .	30
Cleaning . . . . .	30
<b>Troubleshooting</b>	
Troubleshooting . . . . .	31
Deviations in the conveying process . . . . .	32
<b>Abandonment and disposal</b>	
Abandonment . . . . .	33
Disposal . . . . .	33

## Table of contents

### Appendix

Electrical data of connectors .....	34
Installation Declaration .....	37

## Introduction

### Information about the operating instructions

#### Contents

This manual contains important advice, notes and information about the ZoneControl in all phases of its lifecycle:

- Transport, assembly and start-up
- Safe operation, maintenance and troubleshooting, disposal
- Accessories

#### Validity of the manual

The manual describes the ZoneControl as it is delivered by Interroll.

In addition to this manual, special contractual agreements and technical documents apply to special versions.

#### The manual is part of the product

- For trouble-free, safe operation and warranty claims, read the manual and follow the instructions before handling the ZoneControl.
- Keep the manual near to the ZoneControl.
- Pass the manual on to any subsequent operator or occupant of the ZoneControl.
- Interroll does not accept any liability for malfunctions or defects due to non-observance of this manual.
- If you have any questions after reading the operation manual, feel free to contact our customer service. See the last page for your local contact.

### Warnings in this manual



The warnings in this document refer to risks which may arise while using the ZoneControl. For relevant warnings, see *"Safety"*, page 5 and the warnings at the beginning of each chapter.

There are three categories of danger. The following signal words are used in the document as required:

- Danger
- Warning
- Caution

Signal word	Meaning
Danger	Indicates a hazardous situation which, if not avoided, will result in death or serious injury.
Warning	Indicates a hazardous situation which, if not avoided, could result in death or serious injury.
Caution	Indicates a hazardous situation which, if not avoided, may result in minor or moderate injury.

#### Structure of warnings

	 <b>DANGER</b>
<p><b>Nature and source of the hazard</b> Possible consequence of non-observance</p> <p>➤ Information about how to avoid the hazard.</p>	

## Introduction

### Further symbols

#### **NOTICE**

**This symbol identifies possible material damage.**  
➤ Information about how to avoid damage.



This symbol displays safety instructions.



This symbol marks useful and important information.

➤ This symbol marks the steps that have to be carried out.

## Safety

### General safety instructions

The ZoneControl is designed according to the technical state of the art and is reliable in operation, once distributed. However, risks may still arise.

- Risks of physical injury to the user or bystanders.
- Adverse effects of the ZoneControl and other material.



Disregarding the warnings in this manual may lead to serious injury.

- Always read the entire operating and safety instructions before starting to work with the ZoneControl and follow the information contained herein in full.
- Only instructed and qualified persons may work with the ZoneControl.
- Always keep this user manual at hand when working on the ZoneControl so that you can consult it quickly if required.
- Always comply with relevant national safety regulations.
- If you have any questions after reading this user manual, feel free to contact our customer service. See the last page for contact information.

### Intended use

The ZoneControl should only be used for industrial applications and in an industrial environment to control one of the following RollerDrives:

- RollerDrive EC310
- RollerDrive EC300 (with adapter cable)

It must be integrated into a conveyor module or conveyor system. Any other use is not permitted and is deemed to be improper.

Any modifications that affect the safety of the product are not permitted.

The ZoneControl may only be operated within the defined operating limits.

The ZoneControl must be supplied by a regulated power supply unit with a nominal DC voltage of 24 V (minimum 19 V, maximum 26 V).

### Unintended use

Applications not according to the intended use of the ZoneControl require approval from Interroll.

## Safety

### Qualified persons

Qualified persons are persons who read and understand the manual and, taking national regulations into account, can competently execute incidental work.

Only instructed and qualified persons may work with the ZoneControl, taking the following into account:

- the relevant manuals and diagrams,
- the warning and safety instructions in this manual,
- the system specific regulations and requirements,
- national or local regulations and requirements for safety and accident prevention.



## Safety

### Dangers



The following list informs you about the various types of danger or damage that may occur while working with the ZoneControl.

- Persons**
  - Maintenance or repair work must only be executed by authorized and qualified persons in accordance with the applicable regulations.
  - Before using the ZoneControl, ensure that no unauthorized persons are near the conveyor.
- Electricity**
  - Only operate the ZoneControl with control voltage complying with the requirements of EN 60401-1, PELV.
  - Only perform installation and maintenance work after you have switched off the power.
  - Ensure that the power cannot be turned on accidentally.
- Working environment**
  - Do not use the ZoneControl in explosive environments.
  - Always remove materials and objects which are not required from the work area.
- Malfunctioning during operation**
  - Regularly check the ZoneControl for visible damage.
  - In case of fumes, turn off the power at once and ensure that it cannot be turned on accidentally.
  - Contact qualified personnel immediately to find the source the malfunction.
- Maintenance**
  - As the product is maintenance free, you only need to check the ZoneControl regularly for visible damage and that all leads and screws are still tightened.

### Interfaces to other devices

By assembling the ZoneControl in a conveyor module, further hazards may occur. These hazards are not part of this manual and have to be analyzed during the design, installation and startup of the conveyor module.

- After assembling the ZoneControl in a conveyor module, check the whole system for a new potential dangerous spot before switching on the conveyor.

### Operating modes

- Normal mode** Operation of the installed device at the end customer's as a component in a conveyor in a complete system.
- Special mode** All operating modes which are required to guarantee and maintain safe and normal operation.

Special operating mode	Explanation	Comment
<b>Transport/Storage</b>	Loading and unloading, transport and storage	-
<b>Assembly/Initial start-up</b>	Installation at the end customer's and performing the test run	When de-energized
<b>Cleaning</b>	External cleaning	When de-energized
<b>Maintenance/Repairs</b>	Maintenance and inspection tasks	When de-energized
<b>Troubleshooting</b>	Troubleshooting in the event of a fault	When de-energized
<b>Fault elimination</b>	Eliminating the fault	When de-energized
<b>Shut-down</b>	Dismantling from the conveyor	When de-energized
<b>Disposal</b>	Disposal of ZoneControl and packaging	-

## Product information

### Product description

The ZoneControl is used to facilitate zero pressure accumulation conveying, meaning that goods are transported without coming into contact with each other. To achieve this, the conveyor is sub-divided into zones. One zone consists of a RollerDrive, several idler rollers, a ZoneControl and corresponding sensors.

Zero pressure accumulation conveying is achieved by there being only one product in every zone and by the zones retaining the package until the downstream zone is detected as being "free" by the corresponding sensor. When accumulation occurs, a signal is transmitted upstream to retain the next package. A gap is always left between the goods being transported so that no accumulation pressure occurs.

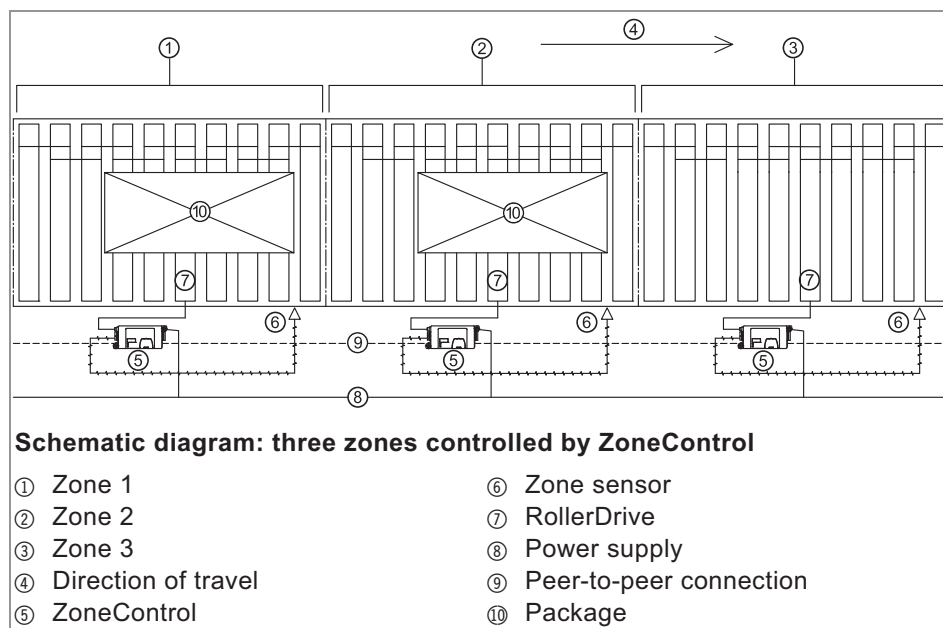

The sensor in zone 1 has detected a package. The ZoneControl in zone 1 sends a request to zone 2 to ask whether the package can continue to be conveyed. Since zone 2 also contains a package, its ZoneControl denies permission until this package has been transferred to zone 3 (singulated release mode) or at the very least its onward transport has been started.

In singulated release mode, the package is only conveyed on if the package in the downstream zone has fully left this zone. In train release mode, the packages are virtually transported simultaneously (with a time delay of approx. 125 ms to reduce peak current when starting up.)

The ZoneControl in zone 1 only activates the RollerDrive in this zone after it receives the corresponding signal from the ZoneControl in zone 2.

## Product information

### Functions

- The speed and direction of rotation of a RollerDrive EC310 (or EC300 with adapter cable) can be controlled.
- The signals from two sensors (start and zone sensors) can be evaluated.
- The feeding of packages into the start zone can be controlled by a sensor or by an external signal.
- Transport logic can be influenced by external control signals (ZONE\_START, ZONE\_STOP, ZONE\_STATUS, CLEAR, DIR\_RET), enabling different functions:
  - Automatic stop at personal gates
  - Individual zone stops within the conveyor line
  - Clearing the entire system in or against the set direction of rotation
  - Feed-in/removal of packages outside of the start and end zone (for instance in conjunction with an external handling system)
- The control signals can either be processed in PNP mode or in NPN mode.
- Regenerative braking: When the RollerDrive motor brakes, it acts as a generator and feeds energy back into the power supply. The DriveControl is fitted with a brake chopper.

### Speed settings

The speed of the RollerDrive can be adjusted in two different ways by ZoneControl:

- Internally at eight levels by means of three DIP switches
- Externally continuously via the analog input SPEED (is handled with priority and enables more fine-tuned adjustment)

The speed setting is converted to an analog control voltage by the ZoneControl and output by the RollerDrive as a reference setting. This reference setting is independent of the RollerDrive gears and their diameter.

Speed setting of the see "*Speed setting*", page 27.

The acceleration and braking behaviour of the RollerDrive is defined by its own moment of inertia, the gears used, the conveying speed, the moment of inertia of connected conveyor rollers, the selected torque transmission and the goods transported.

### Feedback of energy / Overvoltage protection

If the RollerDrive is stopped by the ZoneControl or if the speed is reduced abruptly, the kinetic energy of the package is regeneratively converted into electrical energy in the motor. This energy is then fed back into the ZoneControl, resulting in increased voltage in the DC-net. This is limited to a non-critical level (28 V) by the integral brake chopper. However, if there are enough other consumers attached to the DC-net, the voltage rise will be low and the energy will be fed back in, resulting in the energy being available to other consumers in the DC-net and energy-savings being made if conditions are favourable.

### Temperature protection

If operational conditions mean that the brake chopper is switched on so often that the upper temperature limit of approx. 90 °C (measured internally) is reached, then the ZoneControl switches off. If temperature protection is active, this is shown on the LED display. When the ZoneControl has cooled down, the RollerDrive restarts automatically when a signal is pending.



### CAUTION

#### Unintended start-up of the RollerDrive following the ZoneControl cooling down

Danger of crushing of limbs and damage to goods

- Ensure that no start signal is pending during the cooling-down process.

### Lock period for signal modifications / Debouncing

The external signal inputs, the sensor connections and the DIP switches are protected by the firmware to guarantee operation in the event of edge-unstable and bouncing input-levels. This means that after a signal status change, there is a time gap of 20 ms in which no additional status change is accepted. The sample applies to the sensor inputs, where signal status changes are only processed 50 ms after a signal modification.

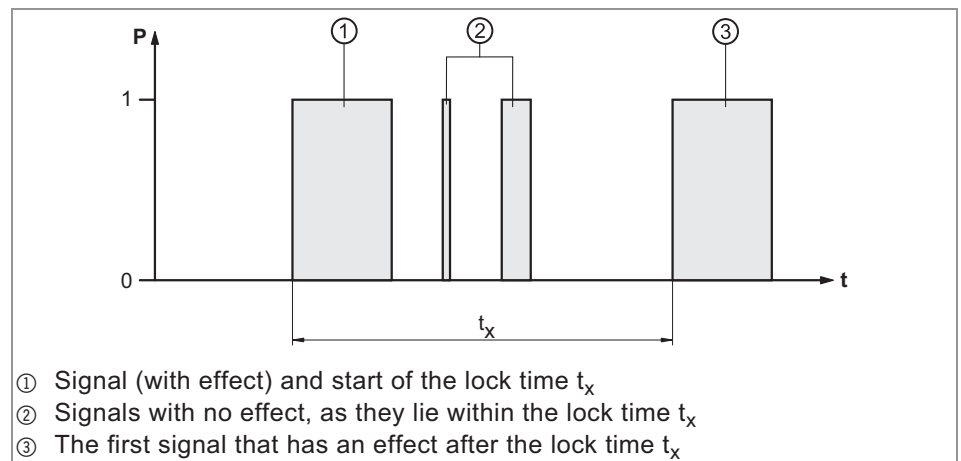

### After-run time

Once a package has left the sensor of a zone, then the RollerDrive in this zone continues to run for additional 4 seconds. At the end of 4 seconds, the RollerDrive stops, providing no new package is transferred from the upstream zone.

This feature provides the following benefits:

- Energy-savings by switching off the RollerDrive if no further packages have to be transported.
- Avoidance of unnecessary start/stop operation if there are no gaps between the packages.

## Product information

### Components

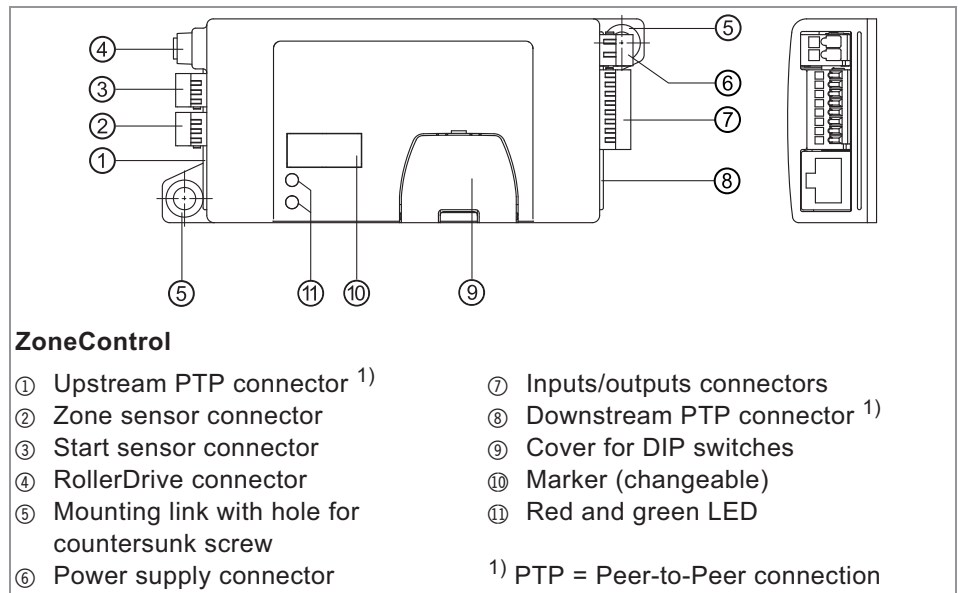

### Scope of delivery

The ZoneControl contains the following components:

- ZoneControl
- Mating plug for power supply (WAGO 734-102/xxx-xxx)
- Mating plug for inputs/outputs (WAGO 733-108/xxx-xxx)
- Spare tool for power supply mating plug (black)
- Spare tool for inputs/outputs mating plug (yellow)

### Label

The information on the label is used to identify the ZoneControl.



## Product information

### Technical data

Rated voltage	24 V DC
Voltage range	19 to 26 V DC (no polarity protection) <sup>1)</sup>
Current consumption	with RollerDrive: 3 to 5 A without RollerDrive: 0.08 A to 0.5 A
Protection classification	IP20
Cooling	Convection
Ambient temperature in operation	0 °C to 40 °C (32 °F to 104 °F)
Air humidity	5 to 95 %, condensation not permissible
Installation height above sea level	max. 1,000 m (max. 3,300 ft)

<sup>1)</sup> A single ZoneControl is protected against reverse polarity connection of the operation voltage. Polarity protection is gone as soon as assemblies are connected via PTP.

### Meaning of the LEDs

The LEDs indicate the operating condition of the ZoneControl and the RollerDrive and provide information about the operating voltage.

LED green	LED red	Meaning	Behaviour of RollerDrive
Flashing <sup>2)</sup>	Flashing <sup>2)</sup>	Initialisation of ZoneControl	Depending on sensor assignment
On steady	Off	ZoneControl ready for operation	Stop
Flashing <sup>2)</sup>	Off	RollerDrive receives start signal	Rotates
On steady	Flashes once <sup>2)</sup>	RollerDrive faulty or not connected	Stop
On steady	Flashes twice <sup>2)</sup>	Fault in conveyor process (for instance jammed package)	Stop
On steady	Flashes three times <sup>2)</sup>	Shutdown due to excessive temperature in chopper resistance	Stop
Off	Flashes four times <sup>2)</sup>	System error (for instance PTP cable disconnected)	Stop
Off	On steady	Fuse triggered	Stop

<sup>2)</sup> Depending on the error, the LED flashes in different sequences (0.5 s on - 0.5 s off) within a period of 4 seconds.

## Product information

### DIP switches

The DIP switches can be used to select the speed, direction of transportation, operating mode and logic conversion (PNP/NPN). Factory default of the DIP switches 1 to 3 is ON and that of DIP switches 4 to 8 is OFF.

DIP switches	ON	OFF
DIP SPEED A, B, C	Speed setting (see "Speed setting", page 27)	
DIP EPA/BA	Train release mode (BA) <sup>1)</sup>	Singulated release (EPA) <sup>1)</sup>
DIP DIR	RollerDrive rotates in an anti-clockwise direction <sup>2)</sup>	RollerDrive rotates in a clockwise direction <sup>2)</sup>
DIP PNP/NPN	Signals are emitted in accordance with NPN logic	Signals are emitted in accordance with PNP logic

<sup>1)</sup>see "Product description", page 8

<sup>2)</sup>The direction of rotation is seen from the connecting cable side, if the external input DIR\_RET is not switched. Combined with a signal at the CLEAR signal input, the direction of rotation is reversed if the DIR\_RET input is switched.

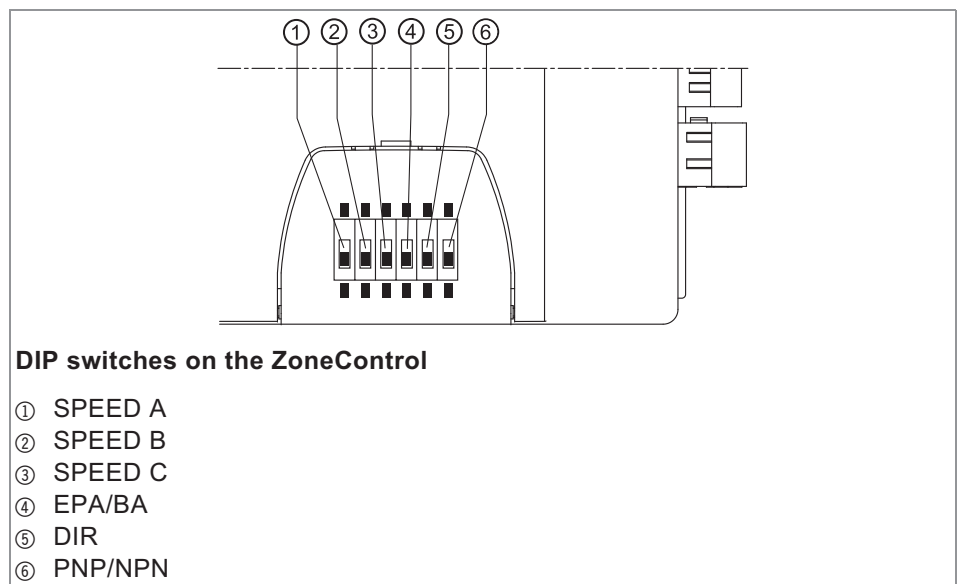

## Product information

### Meaning of signals

#### ZONE\_STATUS

The ZONE\_STATUS signal is the output signal of the handshake function of the ZoneControl. The assigned signal input is ZONE\_START.

The ZONE\_STATUS signal is active when:

- The ZONE\_START signal is active.
- The start or zone sensor is occupied (by regular in-feed of a package or by placing a package on a previously empty zone).

The ZONE\_STATUS signal gets in-active when:

- A package initially standing is conveyed into the following zone. When the zone sensor becomes free, the ZONE\_STATUS gets in-active providing no further package is following.
- If a package does not reach the zone sensor, the system assumes after 5 seconds that the package has been manually removed and the ZONE\_STATUS signal gets in-active.
- If a standing package is removed manually (and the zone sensor gets thereby freed), the RollerDrive continues rotating for 2 seconds. If the sensor is not occupied again during this time and no other package follows, the ZONE\_STATUS signal gets in-active.

### Dimensions

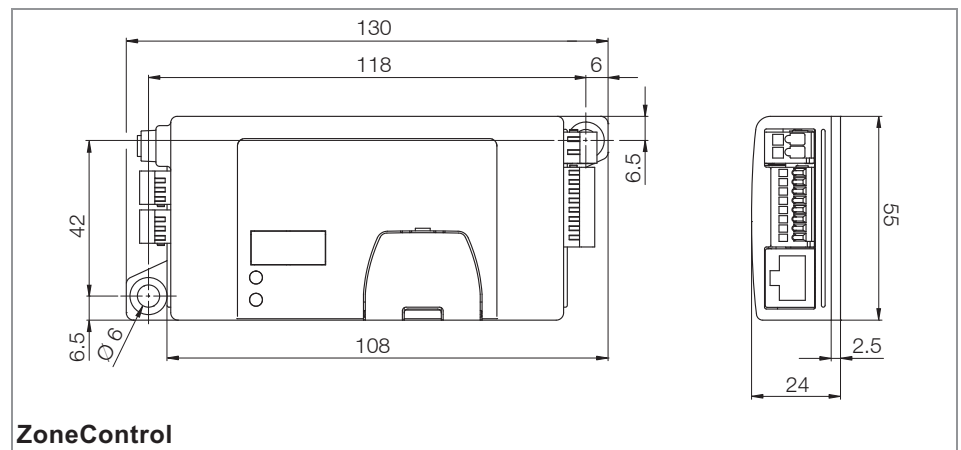





## Transport and storage

### Ambient conditions for transport and storage

Permissible ambient temperature	-20 °C to 70 °C (-4 °F to 158 °F)
Permissible relative humidity	5 to 95 % Condensation not permissible.



### Transport

- Every ZoneControl is packaged in its own cardboard box.

	 <b>CAUTION</b>
	<b>There is a risk of injury if transported incorrectly</b> <ul style="list-style-type: none"><li>➤ Only qualified and authorized persons should transport the product.</li><li>➤ Follow the instructions below.</li></ul>

- Do not stack more than four cardboard boxes on top of each other.
- Check that the ZoneControls are correctly fixed prior to transport.
- Avoid serious impacts during transport.
- Check every ZoneControl for visible damage and completeness (mating plugs and spare tools) following transport (see "Scope of delivery", page 11).
- In the event of damage, take photos of the damaged parts.
- Report any damage caused by transport immediately to the transport company and Interroll to retain the right to claim for compensation.
- Do not expose the ZoneControls to serious fluctuations in temperature as this could lead to condensation.

### Storage

	 <b>CAUTION</b>
	<b>Risk of injury due to improper storage</b> <ul style="list-style-type: none"><li>➤ Do not stack more than four cardboard boxes on top of each other.</li></ul>

- Check each ZoneControl for damage after storage.

## Assembly

### Warning notices concerning assembly

#### **NOTICE**

**Risk of damage leading to failure or shortened life expectancy of the DriveControl**

- Follow the instructions below.

- Do not drop or mishandle the ZoneControl to avoid internal damage.
- Check each ZoneControl visually for damage before assembly.

### Warning information relating to the electrical installation

#### **NOTICE**

**Risk of damage to the ZoneControl**

- Observe the following safety information.

- Electrical work should only be performed by qualified and authorised persons.
- Disconnect the power supply before installing, removing or rewiring the ZoneControl.
- Ensure that no hazardous voltage can come into contact with the connections or the housing, not even in the event of a malfunction or fault.
- Do not connect AC current to the RollerDrive or the ZoneControl at any time, as this will cause irreparable damage to the device.
- Do not use earth connections or earth wires as a protective conductor (PE).
- Do not apply too much tension or load to the motor connector. The cable insulation can become damaged if the cable is bent at the plug and the ZoneControl or the RollerDrive could fail.
- Only use cables that are dimensioned sufficiently for the application.
- Ensure that current load at each terminal or terminal block does not exceed 10 A.
- Ensure that the switching power supply unit supplying the DriveControl supplies a nominal DC voltage of 24 V with a maximum deviation of  $\pm 8\%$ .
- Ensure that the RollerDrive, the ZoneControl and the voltage source are connected to the conveyor frame or supporting structure in such a way that they are properly earthed. Incorrect earthing can result in the build-up of static charge, causing the motor or ZoneControl to malfunction or fail prematurely.
- Only use the specified mating plug (see "Inputs and outputs", page 20) and the spare tool supplied.
- Ensure that the ZoneControl is not reverse connected. The ZoneControl will be damaged beyond repair when power is applied if the ZoneControl is reverse connected and there is a peer-to-peer connection.
- Only apply operating voltage when all of the cables have been connected.

## Assembly

### Installing the ZoneControl in a conveyor system

- Locate a flat surface for mounting the ZoneControl.
- Use the ZoneControl as a template and mark the centre of both mounting holes. For the distance between the holes, see "Dimensions", page 14.
- Drill two  $\varnothing$  5.6 - 6 mm (0.22 - 0.24 in) mounting holes at the marked spots.
- Fasten the ZoneControl.
- Ensure that the housing is not distorted.

### Electrical installation



The ZoneControl is fitted with an internal, non-replaceable fuse to protect the DC-net and all of the coupled users against a short circuit in the RollerDrive (or generate current of more than 10 A). The user must protect all other lines.

The ZoneControl should be fixed to the side of the conveyor on which the RollerDrive cable is located. All of the connections should be routed to one side of the conveyor to simplify cabling.

The cabling of the PTP connection must always following the direction of the conveyor, that is to say that the PTP downstream connection of the upstream zone must be connected to the PTP upstream connection of the downstream zone etc. This also applies if one/several ZoneControl(s) have to be fitted on the other side of the conveyor.

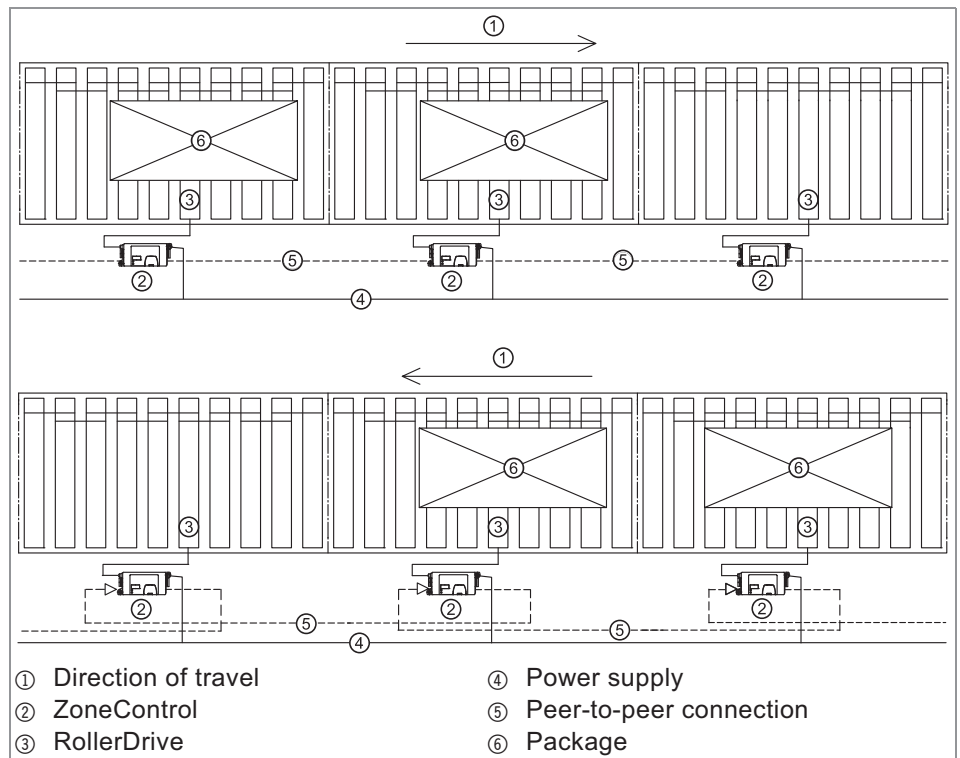

## Assembly

### Required cables

Connection	Conductor cross-section / Information
Inputs/ Outputs	fine-strand: 0.08 to 0.5 mm <sup>2</sup> fine-strand with end-splice: 0.25 to 0.34 mm <sup>2</sup> AWG: 28 to 20 Stripped length: 5 to 6 mm
Power supply	fine-strand, H05(07) V-K: 1.5 mm <sup>2</sup> (optionally with end-splice according to DIN 46228/1) AWG: 16 Stripped length: 6 to 7 mm
Peer-to-peer connection	Commercially-available Cat-5 cable (network or Ethernet cable)

- Strip the strand ends as per the contact manufacturer's recommendations and possibly fit end sleeves.
- Insert the input/output and sensor wires into the mating plug using the yellow tool (see "Inputs and outputs", page 20).
- Insert the power supply wires into the mating plug with the black spare tool.
- Insert the mating plug into the ZoneControl.
- Ensure that all of the ZoneControl are connected to a common ground.
- Adjust the SPEED A, SPEED B, SPEED C, EPA/BA and DIR DIP switches according to requirements (see "Operation", page 26).
- Adjust the PNP/NPN DIP switch according to the signal level being used (applies to sensors and inputs and outputs).
- Insert the plug of the RollerDrive so that the "RD" labelling of the ZoneControl can be read and the "EC310" labelling is to the rear, i.e. cannot be read.
- Insert the plug of the PTP connection. When the ZoneControl is in the start zone and end zone, one PTP connection remains free. There is no need for an end resistor.

### Signal status of inputs

PNP/NPN	Status	ZONE_STOP	ZONE_START	CLEAR	DIR_RET	START/ ZONE_SENS_IN
PNP DIP = OFF	active	+24 V	+24 V	+24 V	+24 V	+24 V
	in-active	–	–	–	–	–
NPN DIP = ON	active	GND	GND	GND	GND	GND
	in-active	–	–	–	–	–

### Signal status of outputs

PNP/NPN	Status	ZONE_STATUS	ERROR	EXT_ON
PNP DIP = OFF	active	+24 V	+24 V	+24 V
	in-active	–	–	–
NPN DIP = ON	active	GND	GND	GND
	in-active	–	–	–

## Assembly

### Schematics of all outputs

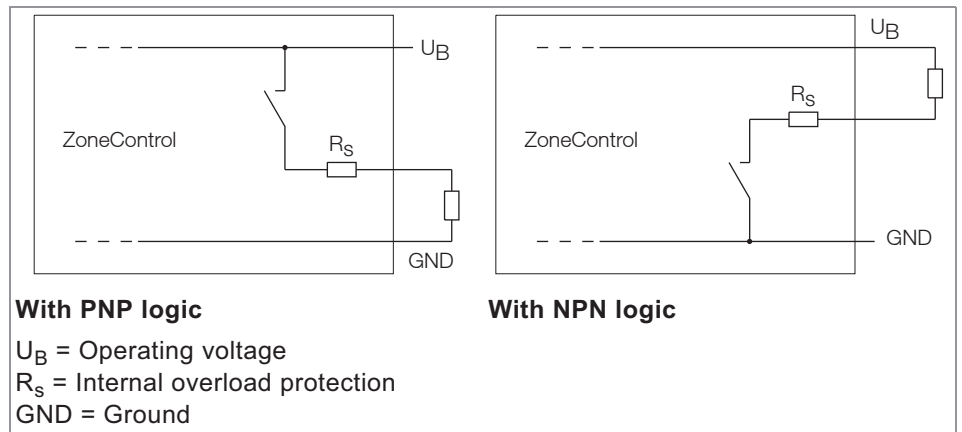

### Sensors

The following types of sensors can be connected (the sensor must be active if the package is in the detection area):

- Light scanner light-switching
- Light barrier dark-switching

Type of sensor	Light- or dark-switching	Opener/ Closer	Logical output	Light beam	Switch symbol	Electrical output		
			Package detected			Switched on	Voltage	
<b>PNP</b> Light barrier (with reflector)	Dark-switching	Closer, normally open	No	Not interrupted		No	–	
			Yes	Interrupted		Yes	24 V	
	Light scanner	Light-switching	Closer, normally open	No	Interrupted		No	–
				Yes	Not interrupted		Yes	24 V
<b>NPN</b> Light barrier (with reflector)	Dark-switching	Closer, normally open	No	Not interrupted		No	–	
			Yes	Interrupted		Yes	0 V	
	Reflective light scanner	Light-switching	Closer, normally open	No	Interrupted		No	–
				Yes	Not interrupted		Yes	0 V

## Assembly

### Inputs and outputs

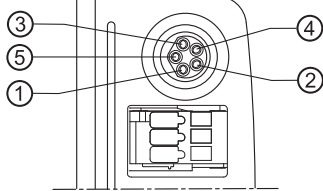

**RollerDrive connection: 8 mm snap-in, 5-pin, pin location in accordance with DIN EN 61076-2**

① +24 V DC	④ Fault input
② Output for direction of rotation	⑤ Speed output
③ Ground	

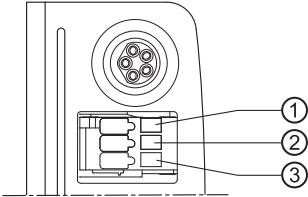

**Start sensor connector: WAGO 733-103 mating plug**  
WAGO 733-363/105-604

① +24 V DC	③ Ground
② START_SENS_IN (input for start sensor signal)	

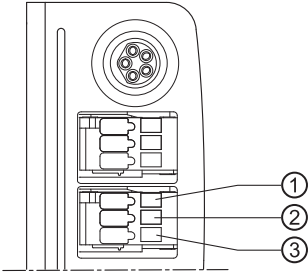

**Zone sensor connector: WAGO 733-103 mating plug**  
WAGO 733-363/105-604

① +24 V DC	③ Ground
② ZONE_SENS_IN (input for zone sensor signal)	

## Assembly

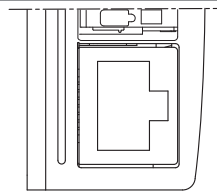

**Upstream peer-to-peer connection: RJ45 socket, 8-pin Molex 43860**

Mating plug: pre-manufactured patch cable

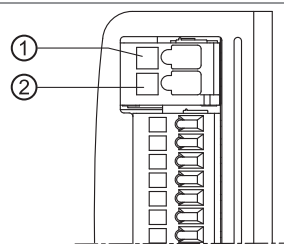

**Power supply connector: WAGO 734-102 mating plug**

WAGO 734-162/105-604

① GND (Ground)

② +24 V DC

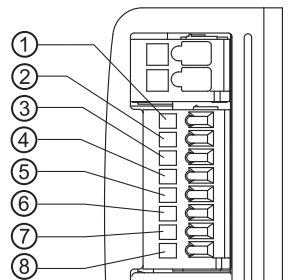

**Inputs/outputs connector: WAGO 733-108 mating plug**

WAGO 733-368/105-604

① EXT\_ON (Output for additional start signal)  
 ② CLEAR (Input for clear signal)  
 ③ SPEED (Input for speed setting)  
 ④ DIR\_RET (Input for change of transport direction and only effective when there is an active signal at CLEAR).

⑤ ERROR (Output for error signal)  
 ⑥ ZONE\_STATUS (Output for zone status signal)  
 ⑦ ZONE\_START (Input for start signal)  
 ⑧ ZONE\_STOP (Input for stop signal)

## Assembly

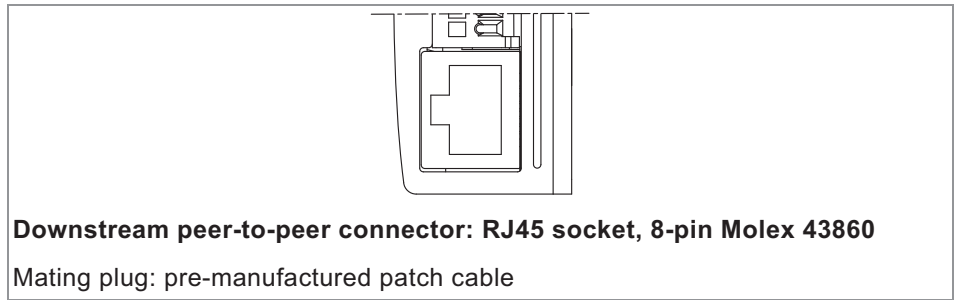

The electrical data for each connection is specified in the appendix (see "Electrical data of connectors", page 34).

## Wiring diagrams

Abbreviations used

+24 V	Operating voltage
GND	Ground (earth)
PTP	Peer-to-peer connection

### ZoneControl within the conveyor section

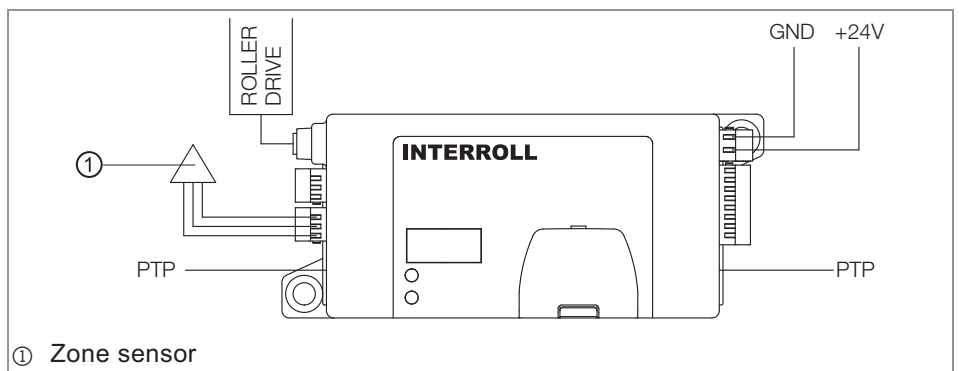

This ZoneControl can be located at any position between the start and end zone. This switch enables zero pressure accumulation conveying without additional functions.

The ZoneControl is connected to the adjacent ZoneControls via the Peer-to-Peer cable. The zone sensor is fed with operating voltage via the sensor connector.



## Assembly

### ZoneControl at the start of the conveyor section

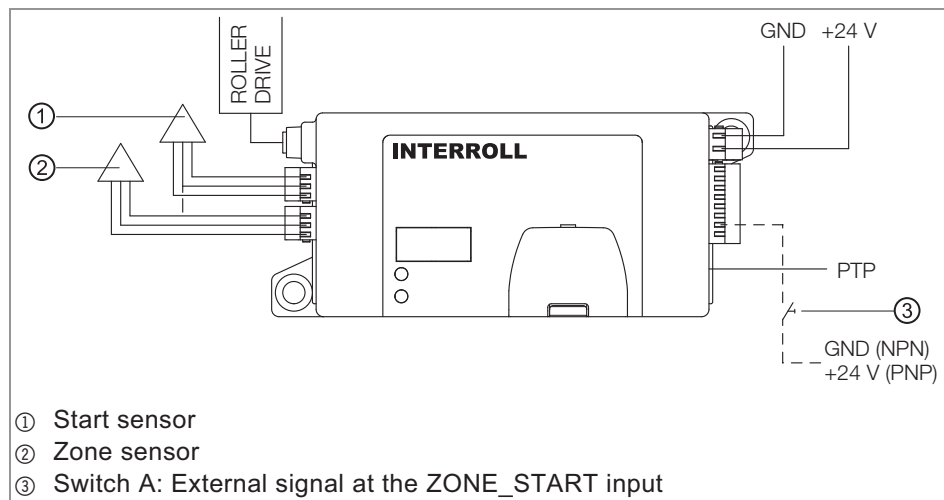

Handshake to the upstream conveyor section: Der Zonenstatus (belegt oder frei) kann über das Signal ZONE\_STATUS abgefragt werden (see "ZONE\_STATUS", page 14). The first zone of the ZoneControl conveyor can be started in the following ways:

- Start sensor (button A is not needed)
- External signal at the ZONE\_START input (symbolised by switch A; start sensor not needed)

The function of the switch can be provided using any switching element (e. g. PLC). The signal can be switched in NPN or PNP mode.

## Assembly

### ZoneControl at the end of the conveyor section

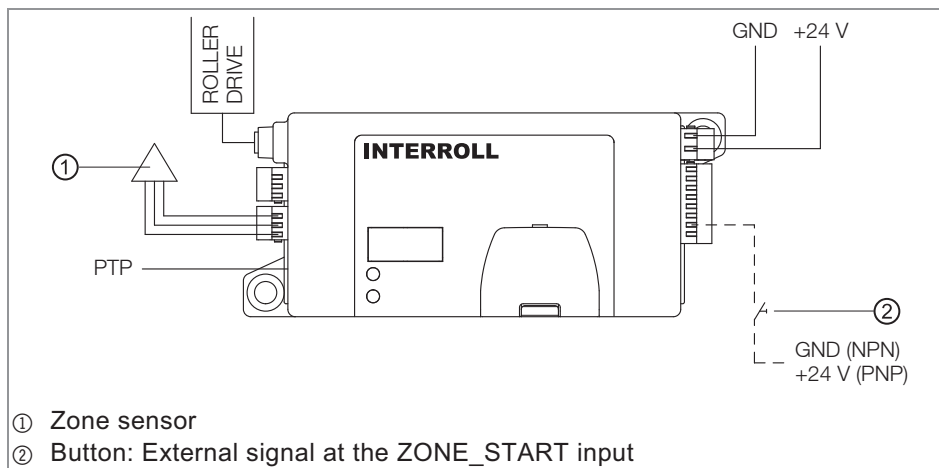

When the package has reached the sensor in the last zone it is stopped by default. An external signal must be given at the ZONE\_START input of the last zone to discharge. This can be a switch (refer to the example in the diagram above) or an external control (PLC). The signal can be switched in NPN or PNP mode. The status of the last zone is given by the ZONE\_STATUS output. If there is no package in the relevant zone sensor's detection range and the ZONE\_START signal is active, the RollerDrive does not rotate.

Depending on signal length and discharge mode (single or train release) either one or more packages will be released.

### Connection of the external speed control

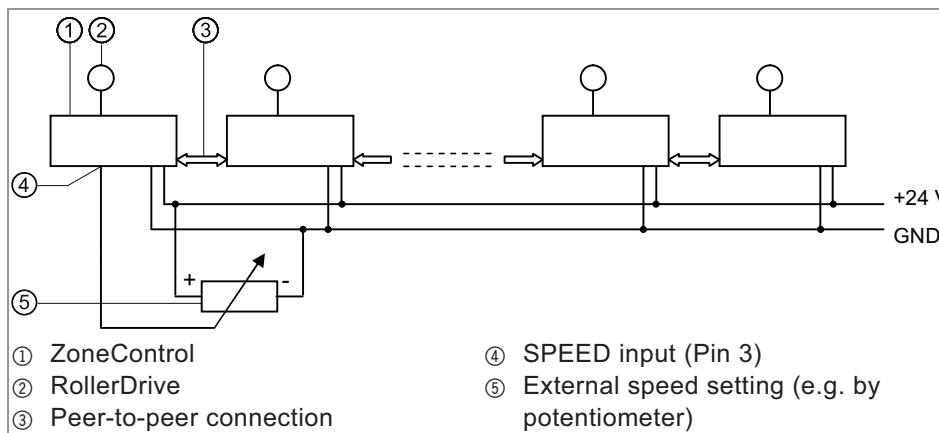

An external SPEED signal can be connected to control the speed of the whole conveyor externally. The signal should only be connected to one ZoneControl, as it is transmitted via the PTP connection to all other ZoneControl. The position of the ZoneControl within the conveyor and the cable length of the PTP connection is immaterial.

The voltage range for the SPEED signal is between 0 and 10 V DC with a maximum current of 2 mA. DC voltage must be kept stable to maintain a constant conveyor speed.

## Assembly

### Connection of a second RollerDrive

There is an option with a conveyor to drive zones with other RollerDrive that are switched on and off synchronously to the RollerDrive of the ZoneControl. This can, for instance be necessary with heavy packages or long zones.

- Connect the EXT\_ON output of the ZoneControl to the SPEED A input of a DriveControl 20.

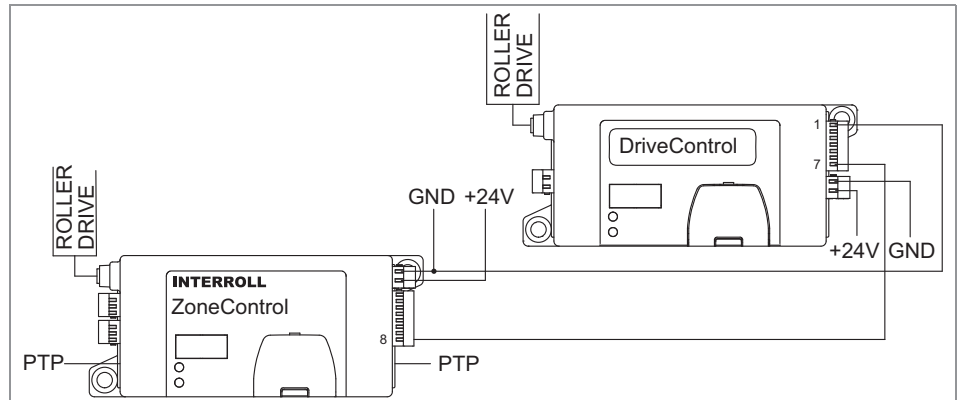

- Connect the ground wire of the ZoneControl (GND) to the signal ground Common GND of the DriveControl 20. If possible, use the same power supply for the ZoneControl and DriveControl 20.
- Preselect a speed that is comparable to that of the ZoneControl on the DriveControl 20 using DIP switches SPEED A to D.
- If the function DIR\_RET is to be used in the application, connect the DIR input of the DriveControl 20 to the DIR\_RET signal of the ZoneControl and on the DriveControl 20 set the DIP switch DIR in such a way that the RollerDrive is rotating in the correct direction.



Changes to the speed via an external SPEED signal only affect RollerDrive that are connected directly to a ZoneControl. The RollerDrive that is connected to a DriveControl 20 do not experience any change of speed from the signal.

## Initial startup and operation

### Commissioning

#### Pre-commissioning checks

- Ensure that the ZoneControl has been correctly fastened to the profile and that all screws have been correctly tightened.
- Ensure that there are no additional areas of danger caused by interfaces to other components.
- Ensure that the wiring is in accordance with the specification and legal directives.
- Check all protection devices.
- Ensure that no personnel stand in hazardous areas near the conveyor.

#### Pre-commissioning checks

- Check the ZoneControl for visible damage.
- Check the DIP switch settings (see "DIP switches", page 13).
- Check all protection devices.
- Clearly specify and monitor the way goods are placed on the conveyor.
- Ensure that the RollerDrive is not blocked.
- Ensure that no personnel stand in hazardous areas near the conveyor.

### Operation



#### **CAUTION**

##### **Accidental start-up of the RollerDrive**

Danger of crushing of limbs and damage to goods

- Ensure that no unauthorised persons are near the conveyor before switching on the operating voltage.



Ambient conditions during operation see "Technical data", page 12

The ZoneControl is initialised after the operating voltage has been applied. The ZoneControl is then brought into a defined basic state and packages that are not within the detection range of a sensor are transported onto the next zone sensor. The RollerDrives in unoccupied zones rotate and RollerDrives in occupied zones do not rotate. The start and end zones are automatically detected if they are wired correctly. Initialisation mode takes 4 seconds. During the initialisation mode the zone sensor can be assigned as often as required.

## Initial startup and operation

### Speed setting

#### Internal speed setting on the ZoneControl

Requirement: The external SPEED input is not connected or in-active.

- Set the required speed using the DIP switches (see table).



It is not possible to stop the RollerDrive by connecting ground to the external SPEED input.

Setting of the SPEED DIP switches on the ZoneControl			Speed at gear ratio								
A	B	C	m/s								
			4:1	9:1	12:1	16:1	24:1	36:1	48:1	64:1	96:1
on	on	on	3.93	1.75	1.31	0.98	0.65	0.44	0.33	0.25	0.16
on	on	off	3.39	1.51	1.13	0.85	0.57	0.38	0.28	0.21	0.14
on	off	on	2.86	1.27	0.95	0.72	0.48	0.32	0.24	0.18	0.12
on	off	off	2.33	1.03	0.78	0.58	0.39	0.26	0.19	0.15	0.10
off	on	on	1.80	0.80	0.60	0.45	0.30	0.20	0.15	0.11	0.07
off	on	off	1.26	0.56	0.42	0.32	0.21	0.14	0.11	0.08	0.05
off	off	on	0.73	0.32	0.24	0.18	0.12	0.08	0.06	0.05	0.03
off	off	off	0.20	0.09	0.07	0.05	0.03	0.02	0.02	0.01	0.01

#### Speed setting via external analog signal

Above a voltage of > 1 V, the SPEED signal has higher priority than the speed setting by the internal DIP switches. The speed of the RollerDrive is controlled by the external signal, irrespective of the position of the DIP switches.

- Set the speed of the RollerDrives by changing the external signal within a range of 1 to 10 V. Changes to the signal will only be applied if they differ by at least 0.1 V from the previous value.
- Set the external signal to 0 V to enable the internal speed setting by the DIP switch.



The specified analog speed applies to all zones of the ZoneControl conveyor.

### External influence on zero pressure accumulation conveying

The ZoneControl has two control signals to specifically influence the otherwise automatic conveyor process.

- ZONE\_START
- ZONE\_STOPP

These signals enable the current conveyor logic of a zone to be interfered with to the extent that locally generated START-STOP processes can be integrated easily and simply into the parallel running global ZPA conveyor process.

	<p><b>CAUTION</b></p> <p><b>Accidental start-up of the RollerDrive</b> Danger of crushing of limbs and damage to goods</p> <ul style="list-style-type: none"> <li>➤ Before enabling the ZONE_START and ZONE_STOPP signals, ensure that no unauthorised persons are in the conveyor's hazard zones.</li> </ul>
---	---

## Initial startup and operation

### ZONE\_STOPP

- Can be used at every zone.
- Package is conveyed to the zone sensor in the affected zone.
- When in-active, immediate transition to normal ZPA conveyor operation.
- The signal does not stop the RollerDrive immediately.

### ZONE\_START

The ZONE\_START signal is the input signal of the handshake function of the ZoneControl. The associated signal output is ZONE\_STATUS (see "ZONE\_STATUS", page 14).

- Connected to the first zone of the conveyor:
  - The start signal leads to the RollerDrive in the first zone starting, providing that the zone sensor is not occupied.
  - If the zone sensor is occupied, the RollerDrive will not be started.
  - If the signal is active while a package is conveyed into the first zone, the RollerDrive will continue running until the package reaches the sensor (resulting in no Time-Out).
  - If the ZONE\_START remains active after the package has left the first zone, the RollerDrive in the first zone will continue running without a time-out.
- Connected to a middle zone:
  - The RollerDrive in the zone starts running immediately and under compulsion disregarding any ZPA- or sensor status. (Caution: Risk of collision). If the signal gets inactive, the zone again follows the rules of zero pressure accumulation conveying. No initialisation takes place.
- Connected to the last zone:
  - If the last zone is occupied by a package, it is conveyed out of this zone. If no further package follows, the RollerDrive stops after 4 seconds (run-on).
  - If a further package is following, then it is also conveyed out of the zone (depending on the type of discharge set) providing ZONE\_START continues to be active.
  - If the signal is only given as a pulse, a package is conveyed out of the zone, a further package would be conveyed to the zone sensor and stop there.
  - If the start signal is given and the last zone is not occupied, the RollerDrive does not run.
  - If the signal remains active and a package is conveyed to the last zone, the RollerDrive does not stop but the package is transported directly out of the zone.



The ZONE\_START and ZONE\_STOPP signals should be given as pulses to guarantee functional assignment to the ZPA conveyor process. The duration of the pulse should be shorter than the time the longest package takes to go through the shortest zone.

## Initial startup and operation

### Complete clearing of a conveyor

A conveyor can be completely cleared by the CLEAR signal if required.

➤ Activate the CLEAR signal in the first or last zone of the conveyor. The CLEAR signal is transmitted via the PTP cable to all other zones. It immediately overrides the running conveyor logic and it must be kept active as long as the clearing of the conveyor takes. It causes forced conveyance: All RollerDrive rotate simultaneously at the respectively preset speed and in the preset direction without taking the zone sensors into consideration.

Any CLEAR signal connected to an intermediate zone is ineffective. CLEAR cannot be active while the ERROR signal is activated.

As soon as the CLEAR signal is inactive again, the conveyor goes through an initialisation cycle.

If the DIR\_RET signal is active parallel to the CLEAR signal, all of the connected RollerDrive rotate in the opposite direction than set by the DIP switch. DIR\_RET and CLEAR must be connected to the same ZoneControl. The DIR\_RET signal is only effective during CLEAR.

## Maintenance and cleaning

### Warnings concerning maintenance and cleaning



#### CAUTION

##### Risk of injury due to improper handling or accidental motor starts

- Maintenance work and cleaning may only be executed by qualified and authorized persons.
- Only perform maintenance work after switching off the power. Ensure that the ZoneControl cannot be turned on accidentally.
- Set up signs indicating maintenance work.

### Maintenance

#### Inspecting the ZoneControl

The ZoneControl itself is maintenance-free. For avoidance of faults however, regular inspection of the connections and fixings is required.

- As part of the regular control and maintenance work on the conveyor, ensure that the screws of the ZoneControl are still tight and that the cables are still laid properly and connected to the terminals.

#### Replacing the ZoneControl

If a ZoneControl is damaged, it has to be replaced.

- Install a new ZoneControl (see "Abandonment", page 33 and see "Installing the ZoneControl in a conveyor system", page 17).

### Cleaning

Dust and dirt in combination with humidity may bridge the electric circuit. Therefore, in a dirty environment, periodic cleaning will help to avoid short-circuits which could damage the ZoneControl.



#### CAUTION

##### Risk of damage to the ZoneControl due to incorrect cleaning

- Do not immerse the ZoneControl in liquids.
- Do not use cleaning agents.

- Clean away dust and soiling if necessary.
- For more thorough cleaning, disconnect the ZoneControl from the power supply, remove (see "Abandonment", page 33), and wipe over with a damp cloth.



## Troubleshooting

### Troubleshooting

Symptom	Possible cause	Help
ZoneControl is not working or is working incorrectly	No power supply	<ul style="list-style-type: none"> <li>➤ Check whether the output voltage of the power supply is within the specified voltage range.</li> <li>➤ Check the connections and correct if necessary.</li> </ul>
	Wrong position of the DIP switches	<ul style="list-style-type: none"> <li>➤ Check and if necessary correct the position of the DIP switches (see "DIP switches", page 13).</li> </ul>
ZoneControl faulty or damaged	Internal fuse triggered or faulty.	<ul style="list-style-type: none"> <li>➤ Replace the ZoneControl.</li> </ul>
RollerDrive is not working	RollerDrive is faulty or no power supply	<ul style="list-style-type: none"> <li>➤ Check whether the output voltage of the power supply is within the specified voltage range.</li> <li>➤ Check the connections and correct if necessary.</li> </ul> <p>The ERROR signal is automatically reset after elimination of the fault and the ZoneControl immediately performs a local reinitialisation of the affected zone.</p>
Conveyor process interrupted	Packages jammed	<ul style="list-style-type: none"> <li>➤ Remove jammed packages.</li> </ul> <p>The ERROR signal is automatically reset after elimination of the fault and the ZoneControl immediately performs a local reinitialisation of the affected zone.</p>
	Overheating of chopper resistor to > 90 °C	<ul style="list-style-type: none"> <li>➤ Allow to cool down.</li> </ul> <p>The ERROR signal is automatically reset after cooling and the ZoneControl continues the conveyor process.</p>
	PTP cable disconnection	<ul style="list-style-type: none"> <li>➤ Check all of the PTP cable connections.</li> </ul>
System error	PTP cable disconnection	<ul style="list-style-type: none"> <li>➤ Switch operating voltage off and on to reinitialise the conveyor system.</li> </ul>

The error signal is active in the event of the following faults:

- RollerDrive fault
- RollerDrive not connected
- Fuse faulty
- Upper and lower levels of permitted operating voltage transgressed
- Operating voltage has reverse polarity
- Chopper resistor overheating
- System error
- Time-Out: zone sensor does not become free within 5 seconds

### Deviations in the conveying process

#### Removing a package from the detection area of the zone sensor

The zone sensor is freed by manual intervention (withdrawal or removal of a package that has already stopped) or by sliding back:

The ZoneControl detects this state and let the RollerDrive run for 2 seconds in the zone in order to move the package back into the detection area of the zone sensor. Within the 2 seconds there is no signal sent via the PTP link to the upstream zone that the zone is free. This is to prevent an other package from moving in the zone. If the sensor is not occupied by a package within 2 seconds, a free signal is sent to the upstream zone (the ZONE\_STATUS signal becomes in-active).

#### Time-out when leaving the zone sensor

A package does not leave the current detection zone of the zone sensor or does not reach the target area of the downstream zone (e.g. by temporary removal of the package). This can be caused by a blockage on the conveyor track, for instance by the package becoming snagged or a barrier on the conveyor track.

Once the RollerDrive has started, the occupied zone sensor must become free after 5 seconds. If the sensor is still occupied at the end of this time period, the RollerDrive stops. The ERROR output becomes active and the next ZoneControl displays an error by means of the error LED. An assumption is made that the package is blocking the conveyor.

The time period of 5 seconds can result in long packages not being able to be conveyed at a slow speed.

The error can be reset by pushing the package manually into the detection area of the zone sensor in the downstream zone. By doing this, a zone sensor that did not become free, should no longer be occupied. After elimination of the fault, the affected zone runs a local initialisation.

#### Time-out when reaching the zone sensor

As soon as a package has left the detection area of a zone sensor, the package has 5 seconds time to occupy the zone sensor in the subsequent zone. This means that the RollerDrive in the following zone runs for at least 5 seconds, providing its zone sensor is not previously occupied. At the end of the 5 seconds, the ZoneControl assumes that the package has been removed and stops the RollerDrive. No error is active.

A further package that is occupying the zone sensor in the upstream zone, is only transported into this zone on expiry of the 5 seconds, as this zone only transmits a free signal after 5 seconds.

## Abandonment and disposal

### Abandonment



#### **CAUTION**

##### **Risk of injury due to improper handling**

- Abandonment may only be executed by qualified and authorized persons.
- Only abandon the ZoneControl after switching off the power. Ensure that the ZoneControl cannot be turned on accidentally.

- Disconnect all cables from the ZoneControl.
- Unscrew the screws attaching the ZoneControl to the conveyor frame.
- Extract the ZoneControl from the conveyor frame.

### Disposal

The operator is responsible for the proper disposal of the ZoneControl. In doing so, industry-specific and local provisions must be observed for the disposal of the ZoneControl and its packaging.

## Appendix

### Electrical data of connectors

#### Inputs/outputs connectors

#### ZONE\_START, ZONE\_STOP, DIR\_RET, CLEAR, START\_SENS\_IN and ZONE\_SENS\_IN inputs

Properties	24 V logic, bounced, GND reference potential	
Reverse polarity protection	max. 30 V DC	
Overvoltage protection	max. 30 V DC	permanent, absence of harmonic waves
Logic level low	0 to 5 V DC	nnp = active
Input current low	max. 3 mA	
Logic level high	15 to 28 V DC	pnp = active
Input current high	max. 4.5 mA	
Response time for repeated signal change	min. 20 ms	

#### Outputs ZONE\_STATUS, ERROR, RD\_EXT\_ON

Properties	not short circuit-proof	
Output current	50 to 100 mA	at an operating voltage of 30 V, max. 500 ms
Logic level low	0 to 5.5 V DC	open collector, @ 50 mA, Reference GND
Logic level high	12.5 to 30 V DC	open collector, @ 50 mA, Reference GND

## Appendix

### RollerDrive connector

#### Power supply (pin 1, 3)

Nominal value	24 V DC	
Voltage range	18 to 26 V DC	
Residual ripple	max. 600 mV <sub>pp</sub>	
Rated current	0 to 2.3 A	
Peak current	max. 5 A	max. 250 ms > 2.3 A, time-dependent current flow triangular, duty factor ≤ 19 %
Return electric strength	max. 35 V DC	absence of harmonic waves max. 500 ms; after 500 ms the reserve voltage must be ≤ 30 V, duty factor max. 27 %

#### Direction of rotation output (pin 2)

Properties	not electrically isolated, short circuit-proof, infeed of external voltage not permitted	
Overvoltage protection	max. 30 V DC	
Clockwise direction of rotation	max. 4 V	logical 0
Output current low	max. 1 mA	load resistance = 57 kΩ
Anticlockwise direction of rotation	min. 7 V	logical 1
Output current high	max. 0.2 mA	with short circuit

#### Input error (pin 4)

Properties	not electrically isolated	
Reverse polarity protection	max. 30 V DC	
Max. voltage	30 V DC	
Logic level low	max. 8.5 V DC	at 1.5 mA logical 0 = inactive = no error
Fault current low	1.5 mA max. 5 mA	
Logic level high	12 to 30 V DC	logical 1 = active = error
Fault current high	max. 0.01 mA	

## Appendix

### Speed output (pin 5)

Properties	not electrically isolated	
Speed operating range of motor control voltage	2.3 to 10 V DC	RollerDrive rotates
Stop range	0 to 2 V DC	RollerDrive does not rotate
Precision of motor control voltage	5 %	Motor control voltage between 2.3 and 10 V DC at 21 °C
Motor control voltage ripple	250 mV <sub>pp</sub>	50 Ω
Max. load of motor control current	0.16 to 2 mA	Input resistance of RollerDrive: 66 kΩ
Modification speed	4.5 to 5 V/ms	0 - 100 % motor control voltage

## Appendix

### Installation Declaration

in accordance with the EC Machinery Directive 2006/42/EC, Appendix II B

#### The manufacturer:

Interroll Engineering GmbH  
Hoferhof 16  
D - 42929 Wermelskirchen  
Germany

hereby declares with sole responsibility that the product range

- ZoneControl

**is not a ready-to-use machine as defined by the EC Machinery Directive and, therefore, does not fully comply with the requirements of this directive. The commissioning of these conveyor modules is not permitted until conformity of the entire machine/system in which they are installed has been declared in compliance with the EC Machinery Directive.**

The health and safety requirements as stated in Appendix I have been applied. The special technical documents as stated in Appendix VII B have been compiled and will be sent to the responsible authority if necessary.

Person authorized to compile the technical documents: Georg Malina, Interroll Engineering GmbH, Hoferhof 16, D - 42929 Wermelskirchen

#### Applied EC directives:

- Machinery Directive 2006/42/EC
- EMC Directive 2004/108/EC
- RoHS Directive 2002/95/EC

#### Applied harmonized standards:

- EN ISO 12100 Parts 1 and 2 "Safety of machinery - Basic concepts, general principles for design" - Part 1: "Basic terminology, methodology" - Part 2: "Technical principles"

Wermelskirchen, 31st March 2010

Armin Lindholm  
(Managing Director)

(This declaration can be obtained at [www.interroll.com](http://www.interroll.com), if needed.)



## Northern Europe

### Denmark

Interroll Nordic A/S  
Hammerholmen 2-6  
DK-2650 Hvidovre/Denmark  
Tel. +45 36 88 33 33  
Fax +45 36 88 33 72  
dk.sales@interroll.com

Interroll Service  
Tel. +45 36 88 33 88

### Iceland

IBH ehf  
Dugguvogur 10  
104 Reykjavik  
Iceland  
Tel. +354 562 6858  
Fax +354 562 6862  
is.sales@interroll.com

### Finland

Tel. +358 9 54 94 94 00  
Fax +358 9 54 94 94 16  
fi.sales@interroll.com

### Norway

Tel. +47 32 88 26 00  
Fax +47 32 88 26 10  
no.sales@interroll.com

### Sweden

Tel. +46 35 227077  
Fax +46 35 227078  
se.sales@interroll.com

## Western/Southern Europe

### France

Interroll S.A.S.  
ZI de Kerannou  
B.P. 34  
F-29250 Saint Pol de Léon  
Tel. +33 298 24 41 00  
Fax +33 298 24 41 02  
fr.sales@interroll.com

### Italy

Rulli Rulmeca S.p.A.  
Via A. Toscanini, 1  
I-24011 Almè (Bg)  
Tel. +39 035 4300111  
Fax +39 035 545523  
vendita@rulmeca.it

### Portugal

Rulmeca Interroll de Portugal Lda  
Apartado 69, Centro Civico  
P-6201-909 Covilhã  
Tel. +351 275 330 780  
Fax +351 275 990 789  
rulmeca@rulmeca-interroll.pt

### Spain

Interroll España S.A.  
Parc Tecnològic del Vallès  
C/Dels Argenters, 5  
Edificio 1, módulos Bp y Cp  
E-08290 Cerdanyola del Vallès  
Tel. +34 90 211 0860  
Fax +34 93 586 4895  
es.sales@interroll.com

### United Kingdom

Interroll Ltd.  
Brunel Road  
Earlstrees Industrial Estate  
GB-Corby, Northants NN17 4UX  
Tel. +44 1536 200 322  
Fax +44 1536 748 515  
gb.sales@interroll.com

## Central Europe

### Germany

Interroll Fördertechnik GmbH  
Höferhof 16  
D-42929 Wermelskirchen  
Tel. +49 2193 23 0  
Fax +49 2193 20 22  
de.sales@interroll.com

### Austria

Tel. +49 2193 23 187  
Fax +49 2193 23 164

### Belgium

Tel. +49 2193 23 131  
Fax +49 2193 23 164  
be.sales@interroll.com

### Luxembourg

Tel. +49 2193 23 190  
Fax +49 2193 23 164

### Netherlands

Tel. +49 2193 23 151  
Fax +49 2193 23 164

### Switzerland

Tel. +49 2193 23 190  
Fax +49 2193 23 164  
ch.sales@interroll.com

## Eastern Europe

### Czech Republic

Interroll CZ, s.r.o.  
Na Rádku 7/3172  
CZ-69002 Břeclav  
Tel. +420 519 330 210  
Fax +420 519 330 211  
cz.sales@interroll.com

### Hungary

Tel. +36 23 337 891  
Fax +36 23 337 892  
hu.sales@interroll.com

### Poland

Interroll Polska Sp. z o.o.  
ul. Płochocińska 85  
PL-03-044 Warszawa  
Tel. +48 22 741 741 0  
Fax +48 22 741 741 1  
pl.sales@interroll.com

### Slovakia

Tel. +421 2 4363 8102  
Fax +421 2 4342 7294  
sk.sales@interroll.com

### Slovenia

Tel. +386 1 56 56 370  
Fax +386 1 56 56 372

### Turkey

Rol-er Makina San. Ve. Tic. Ltd. Sti.  
Pembegul Sok., Dostlar Apt.  
No. 12 D. 10 Suadiye  
347 40 Istanbul  
Turkiye  
Tel. +90 216 386 37 75  
Fax +90 216 386 38 22  
tr.sales@interroll.com

## Middle East

### Israel

ComTrans-Tech Ltd.  
P.O.B. 17433  
Tel-Aviv 61174  
Israel  
Tel. +972 54 4 27 27 47  
Fax +972 3 7 44 08 64  
il.sales@interroll.com

## Africa

### South Africa

Interroll SA Pty. Ltd.  
P.O. Box 327  
Isando 1600  
37 Director Road, Spartan Ext 2  
1619  
South Africa  
Tel. +27 11 281 9900  
Fax +27 11 252 9083  
za.sales@interroll.com

## North & South America

### USA

Interroll Corporation  
3000 Corporate Drive  
USA-Wilmington, NC 28405  
Tel. +1 910 799 11 00  
Fax +1 910 392 38 22  
us.sales@interroll.com

### Canada

Interroll Components Canada Ltd.  
8900 Keele Street  
Unit 2 & 3  
Concord, Ontario L4K 2N2  
Canada  
Tel. +1 905 660 4426  
Fax +1 905 660 4159  
ca.sales@interroll.com

### Interroll Canada Ltd.

Drives & Rollers Canada  
1201 Gorham Street  
Newmarket Ontario L3Y 8Y2  
Canada  
Tel. +1 905 727 3399  
Fax +1 905 727 3299  
ca.sales@interroll.com

### Brasil

Interroll Logística Ltda.  
Rua Dom João VI, 555  
Parque Industrial S/A  
Pindamonhangaba-SP  
CEP 12412 - 805  
Brasil  
Tel. +55 12 3648 8021  
br.sales@interroll.com

## For other countries in

### South America, please contact:

Interroll España S.A.  
Parc Tecnològic del Vallès  
C/Dels Argenters, 5  
Edificio 1, módulos Bp y Cp  
E-08290 Cerdanyola del Vallès  
Tel. +34 90 211 0860  
Fax +34 93 586 4895  
es.sales@interroll.com

## Asia

### China

Interroll (Suzhou) Co. Ltd.  
Unit 10B, Modern Industrial Square  
No. 333 Xing Pu Road  
Suzhou Industrial Park  
Suzhou, Jiangsu Province  
People's Republic of China  
Postal Code: 215126  
Tel. +86 512 6256 0383  
Fax +86 512 6256 0385  
cn.sales@interroll.com

### Japan

Interroll Japan Co. Ltd.  
302-1 Shimokuzawa  
Sagamihara-shi  
Kanagawa 229-1134  
Japan  
Tel. +81 42 764 2677  
Fax +81 42 764 2678  
jp.sales@interroll.com

### Korea

Interroll Korea Corporation  
Room 301, Dongsan Bldg, 333-60  
Shindang-Dong, Choong-ku  
Seoul  
Korea  
Tel. +822 2 231 1900  
Fax +822 2 254 36 83  
kr.sales@interroll.com

### Singapore

Interroll (Asia) Pte. Ltd.  
386 Jalan Ibrahim  
629156 Singapore  
Republic of Singapore  
Tel. +65 6266 6322  
Fax +65 6266 6849  
sg.sales@interroll.com

### Thailand

Interroll (Thailand) Co. Ltd.  
41/6 Moo 6, Bangchalong,  
Bangplee  
Samutprakarn 10540  
Thailand  
Tel. +66 2 337 0188 91  
Fax +66 2 337 01 92  
th.sales@interroll.com

### India

Interroll Drives and Rollers India Pvt Ltd.  
SF 12, KSSIDC Building, 10<sup>th</sup> Main, III Stage  
Peenya Indl. Estate  
Bangalore - 560058  
India  
Tel. +91 80 2836 4996  
Fax +91 80 4117 0559  
in.sales@interroll.com

## Australia & New Zealand

### Australia

Conveyor Solutions Australia Pty. Ltd.  
70 Keon Parade  
Thomastown  
VIC 3073  
Australia  
Tel. +61 3 9460 2155  
Fax +61 3 9460 2029  
au.sales2@interroll.com

### New Zealand

Automation Equipment (NZ) Ltd.  
45 Colombo Street  
Frankton  
Hamilton  
New Zealand  
Tel. +64 7847 2082  
Fax +64 7847 7160  
nz.sales@interroll.com

## For other countries please see contacts at

www.interroll.com